

ΠΡΟΣΦΟΡΑ ΦΡΕΖΟΚΕΦΑΛΗ «WSX445»





Φρεζοκεφαλή 45° (προσώπου) νέας γενιάς για απόδοση & οικονομία

Περιγραφή	ΤΙΜΗ ΠΡΟΣΦΟΡΑΣ	ΤΙΜΗ ΚΑΤΑΛΟΓΟΥ
WSX445-040A03AR	119,90 €	277,1 €
WSX445-040A04AR	146,40 €	338,2 €
WSX445-050A03AR	130,50 €	300,7 €
WSX445-050A04AR	157,40 €	362,8 €
WSX445-050A05AR	183,90 €	424,0 €
WSX445-063A04AR	169,50 €	390,5 €
WSX445-063A05AR	196,40 €	452,6 €
WSX445-080A04AR	185,90 €	428,9 €
WSX445-080A06AR	238,80 €	549,2 €
WSX445-080A08AR	286,50 €	659,6 €
WSX445-100B05AR	222,00 €	512,7 €
WSX445-100B07AR	275,40 €	635,0 €
WSX445-100B10AR	355,80 €	819,4 €
WSX445-125B08AR	346,20 €	797,7 €
WSX445-125B12AR	442,50 €	1.020,5 €
WSX445-160C10NR	406,90 €	1.044,2 €
WSX445-200C12NR	587,40 €	1.357,7 €
 ΠΛΑΚΙΔΙΑ (8 κοπτές) SNMU140812ANER-M SNGU140812ANER-M	8,70 € 11,00 €	13,00 € 16,00 €

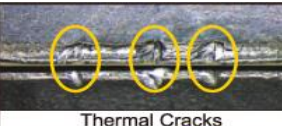

http://mhg-mediastore.net/download/B220%20WSX445/B220E_WSX445_ENGLISH.pdf

ΙΣΧΥΣ ΠΡΟΣΦΟΡΑΣ ΕΩΣ 31 / 7 / 2021

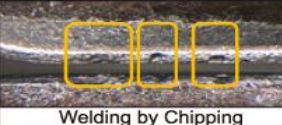
P 	(Al,Cr)N	 Thermal Cracks
	Tough! Thermal Cracks	
M 	TiN	 Notching
	Tough! Notching	
S 	CrN	 Welding by Chipping
	Tough! Resistant Chipping	

ΠΡΟΣΦΟΡΑ ΦΡΕΖΟΚΕΦΑΛΗ «WJX09»

Φρεζοκεφαλή για υψηλές προώσεις και μεγάλη απόδοση σε ξεχόνδρισμα

Περιγραφή	ΤΙΜΗ ΠΡΟΣΦΟΡΑΣ	ΤΙΜΗ ΚΑΤΑΛΟΓΟΥ
WJX09-040A04AR	233,60 €	534,00 €
WJX09-040A05AR	254,60 €	582,00 €
WJX09-050A04AR	238,90 €	546,00 €
WJX09-050A06AR	286,70 €	655,20 €
WJX09-063A05AR	270,90 €	619,20 €
WJX09-063A07AR	321,30 €	734,40 €
WJX09R2502SA25L	218,90 €	500,40 €
WJX09R2503SA25S	246,80 €	564,00 €
WJX09R2802SA25L	225,80 €	516,00 €
WJX09R2803SA25L	260,90 €	596,40 €
WJX09R3203SA32L	276,20 €	631,20 €
WJX09R3503SA32L	276,20 €	631,20 €
WJX09R3504SA32L	312,90 €	715,20 €
 ΠΛΑΚΙΔΙΑ (6 ΚΟΤΕΣ) JOMU 090512ZZER	 11,50 €	18,00€

http://www.mitsubishicarbide.com/application/files/3816/0862/5227/wjx_b235g.pdf

ΙΣΧΥΣ ΠΡΟΣΦΟΡΑΣ ΕΩΣ 31 / 7 / 2021



Wiper Cutting Edge

The wiper edge offers good surface finishes sufficient for rough machining.

Straight Cutting Edge

The straight cutting edge extending to the maximum depth of cut (APMX) allows for high feed machining even at large depths of cut.

Minor Cutting Edge

Stable chip formation is possible with the straight cutting edge even at high ramping angle.

ΠΡΟΣΦΟΡΑ ΦΡΕΖΟΚΕΦΑΛΗ «APX3000»

Η φρεζοκεφαλή για κάθε κατεργασία (πολυλειτουργική)

Περιγραφή	ΤΙΜΗ ΠΡΟΣΦΟΡΑΣ	ΤΙΜΗ ΚΑΤΑΛΟΓΟΥ
APX3000-032A05RA	141,40 €	310,60 €
APX3000-040A06RA	153,20 €	339,20 €
APX3000-050A07RA	188,50 €	415,10 €
APX3000-063A08RA	223,90 €	492,00 €
APX3000-080A09RA	235,80 €	520,60 €
APX3000-100A11RA	294,60 €	648,80 €
APX3000R121WA16SA	79,50 €	175,50 €
APX3000R141WA16SA	79,50 €	175,50 €
APX3000R162WA16SA	100,20 €	220,90 €
APX3000R182SA16ELA	130,80 €	286,90 €
APX3000R182WA16LA	106,10 €	233,70 €
APX3000R182WA16SA	100,20 €	220,90 €
APX3000R202SA20ELA	139,30 €	306,60 €
APX3000R202WA20LA	126,40 €	280,00 €
APX3000R202WA20SA	106,10 €	233,70 €
APX3000R203WA20SA	112,00 €	245,50 €
APX3000R252WA25SA	112,00 €	245,50 €
APX3000R253WA25SA	117,80 €	259,30 €
APX3000R254WA25SA	123,70 €	274,10 €
APX3000R283WA25LA	123,70 €	274,10 €
APX3000R284WA25SA	123,70 €	274,10 €
APX3000R323WA32SA	123,70 €	274,10 €
APX3000R325WA32SA	141,40 €	310,60 €
 ΠΛΑΚΙΔΙΑ (2 κοπές) AOMT 1236..-PEER-M	7,00€	11,00€



<http://mhg->

[mediastore.net/download/B055%20APX3000%204000/B055E APX_english_version.pdf](http://mediastore.net/download/B055%20APX3000%204000/B055E_APX_english_version.pdf)

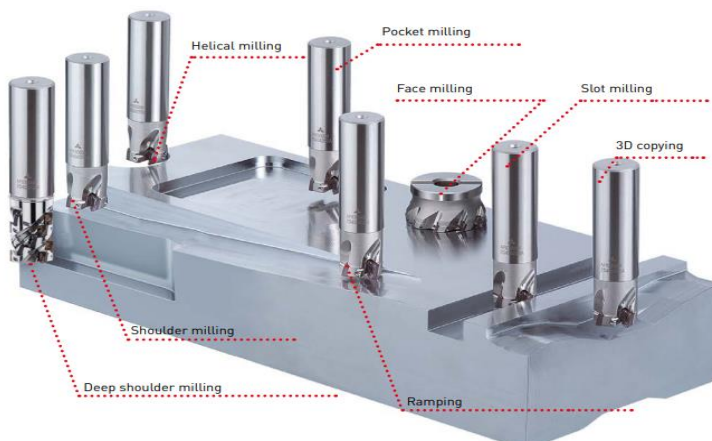

ΙΣΧΥΣ ΠΡΟΣΦΟΡΑΣ

ΕΩΣ 31 / 7 / 2021